



Connecting people with technology

IMPACT Plus Gen 2

#clevertouch | info@clevertouch.com



Key Features

Compatible with Google Workspace and Microsoft 365
You can prepare resources anywhere at any time

Designed for hybrid learning
Students can participate in and out of the classroom

Free apps and software
Clever Software Solutions at no extra cost - Cleverstore, LYNX Whiteboard, CleverLive, Clevershare

Screen mirroring for 50 devices
With 9 mobile devices shown on your IMPACT Plus - Clevershare

Full screen digital signage capabilities
CleverLive App

Customise your home screen
With your school's colours, logos, photos and preferred apps and software - CleverLive

Control and troubleshoot remotely
Via MDM Remote Management

Elevated connectivity
Latest generation USB-C for charging and ethernet, plus all other connectivity ports for connecting a range of devices.

Multi-award-winning education solutions for the digital classroom

IMPACT Plus Gen 2

Interactive large format display designed for the blended learning environment.



Save time lesson planning with subscription-free software



Send messages, alerts and media to all of your Clevertouch screens remotely.



Screen mirroring with built-in teacher controls



High Precision Technology



Apps for Blended Learning



Making integration and installation easier



Best Business Growth
InAvation
2020 - Winner



Education Technology
Innovation of the Year
AV News
2022 - Winner



Innovation, design,
high-quality & functionality
Plus X Award
2020 - Winner



Installation
Best of Show
Award at ISE
Best of Show
2020 - Installation Winner



Best of Show
Tech & Learning
Best of Show InfoComm
2020 - Winner



Best of Show
Installation
Best of Show InfoComm
2020 - Winner

IMPACT Plus Gen 2 Available in a range of sizes

55" | 65" | 75" | 86"

Super Wide Sound

45W Max Power for room-filling sound.

4K

True 4K resolution and sharper user experience throughout.

Cloud Accounts

Sync with your Cloud accounts so that you can work anywhere at any time.



High Precision Technology

Our patented Super Glide Touch technology offers the most fluid writing experience on a touchscreen. It's as smooth as writing on a whiteboard - with no lag. With the ability to differentiate between palm-erase, fingertouch, and stylus-writing, there's no need to change settings mid-flow.

Security Matters

We know how important it is to be secure, so we've got lots of options for you to keep control of your device. Clevertouch can run on-or-off the network. Settings, apps and Android can all be disabled. Data can be wiped at the end of a session and the screen can be locked with a secure passcode.

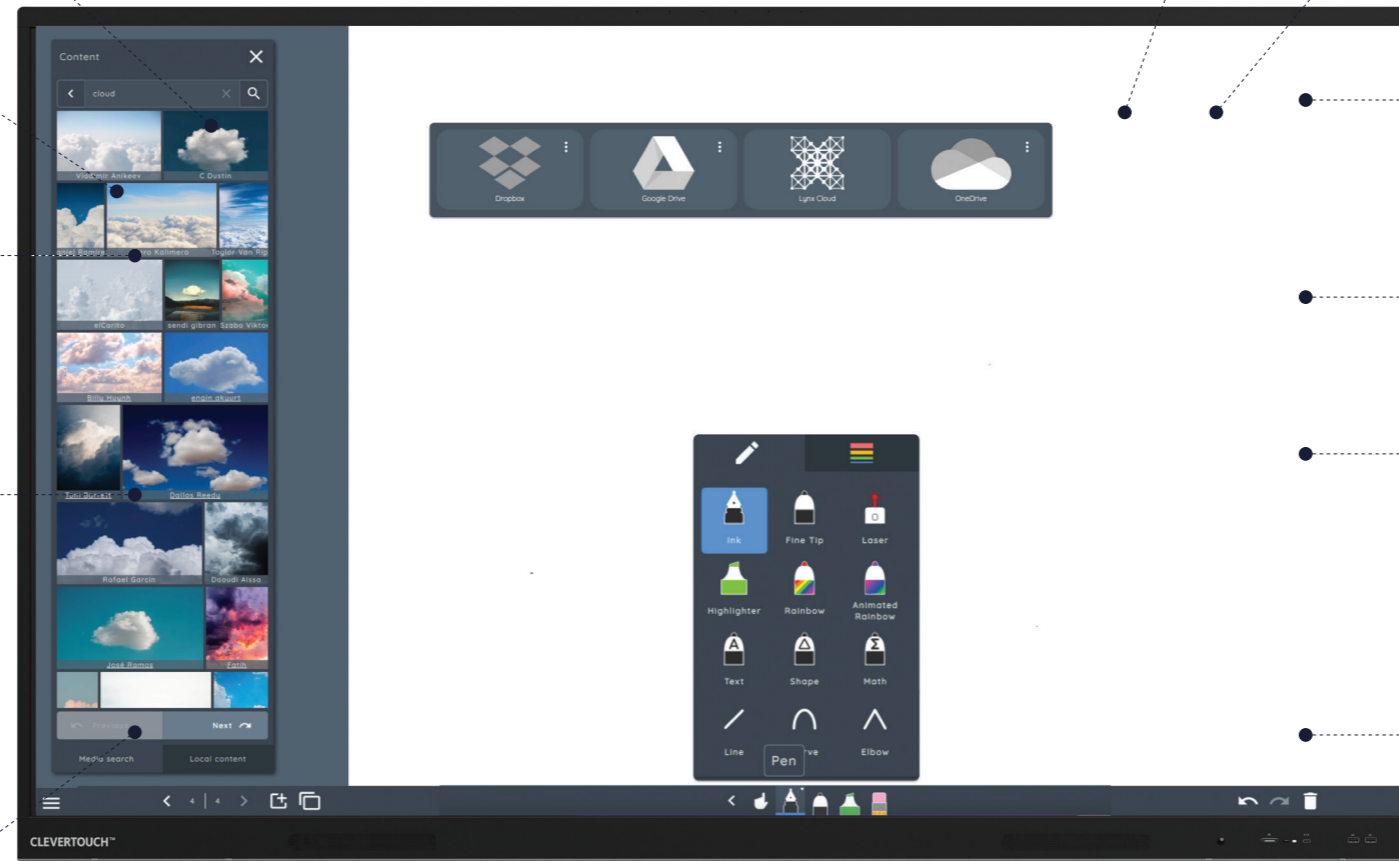

New super cool stylus
Comfort stylus to aid teaching



Microphone
Built-in line array microphone.

Cleverstore 3.0v
Access hundreds of free teaching apps to make lessons more engaging.

Comprehensive Warranty
No ongoing subscription charges.

Infinity Whiteboarding
Never run out of space with our infinite canvas. With numeracy tools, handwriting-to-text recognition, and the ability to insert images and shapes, all of which can be saved, printed or shared to student devices.

Connectivity
Huge connectivity including the latest USB-C port.

Environmentally Friendly Motion Detection
Equipped with Proximity Sensors your Clevertouch will power off when no one is detected in the room.

What's New?



Zero bonding - no air gap gives greater accuracy, improved performance and vibrant imagery

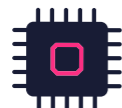

Android 11 4K Chipset - 6GB RAM / 64GB ROM



Front-mounted latest-generation USB-C - allows switching between any device



Front-facing speakers and subwoofer for clearer, more powerful quality audio



Upgraded 6 array microphone



Ambient light sensor



Front-mounted power button



Front-mounted USB-A port



Quick Launch Menu for instant teaching tools

Your most commonly used apps are available with one touch and are easily accessible via the Quick Launch Menu.



The Clevershare App is free to download and compatible with Android, Windows, iOS and Chrome devices. Up to 50 devices can connect with the Clevertouch screen and share content – images, video, and audio. The presenter has full control over what is shared, and can show up to 9 device screens simultaneously, increasing student collaboration and participation within every lesson. Now includes touch-back.



Make notes, diagrams or images, add and scroll through multiple pages, insert an image or change the background colour. Now includes handwriting and formula recognition.



Double click on files to open them, as well as easily copy, cut and paste, so it's just like using a PC. Personal Cloud Storage integration.



Explore the internet without needing a computer, using the IMPACT™, Chrome and Chromium browsers.



Cleverstore contains hundreds of apps in all subjects and a range of languages, including literacy, STEAM and languages. Each app is tested by our team, to make sure no adverts, in app purchases, or inappropriate content gets through. We've partnered with the most popular educational app developers to give you apps that you can really make use of in the classroom.



Easily go back to recently used apps using the Active button with split-screen mode.



Protect your Clevertouch with a password by using Lock.



All of your integrated and Cleverstore apps can be found here.



All your favourite apps in one place, including Settings.



Create your free account at CleverLive.com

Flexible Messaging Solutions

Exclusive to Clevertouch

CleverLive App: Messaging

With CleverLive App your IMPACT isn't just a screen for teaching or presenting, it's also a communications tool. Use it to broadcast messages, alerts and important information to students, staff and visitors.

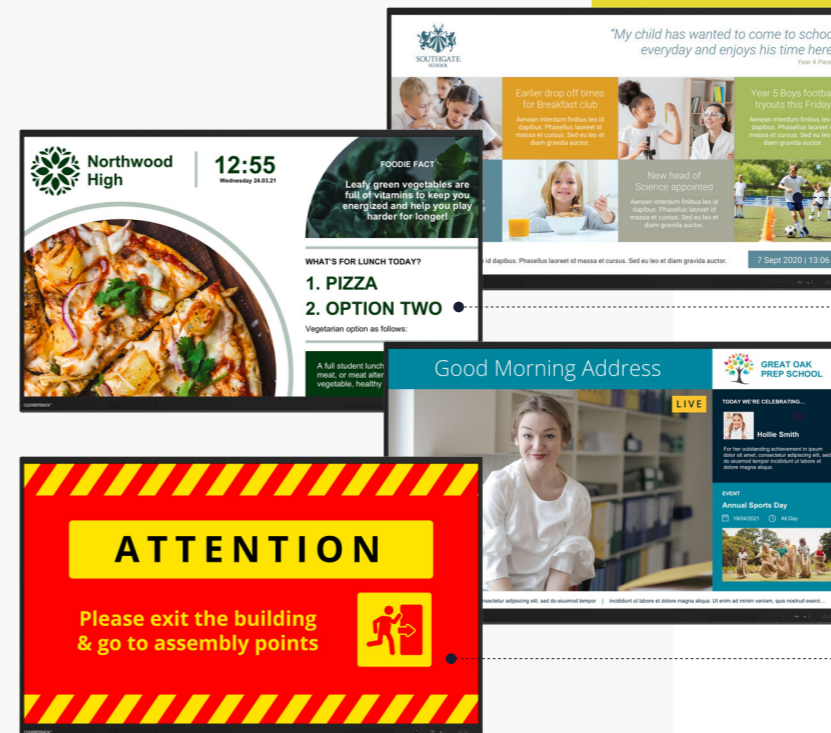

- Daily news and activities
- Weekly lunch menu
- Live video messages from the school office
- Emergency announcements and fire drills



Create your free account at CleverLive.com

Dynamic and integrated

CleverLive: Home Screen

Customise your home screen so it's unique to your school or district. With the CleverLive App, you can group screens so they are representative of your messaging and create user and group profiles.

Personalise your launcher page

- Group by subject, schools, age group, campus, district and more - it's totally flexible
- Show the apps you want. Either from the Cleverstore, or add your own
- Lockdown settings so teachers have to stay within your guidelines
- Add your school logo, colours and background images
- Custom clocks

It's simple!

- 1** Go to CleverLive.com
- 2** Sync your IMPACT screen
- 3** Choose your UI layout

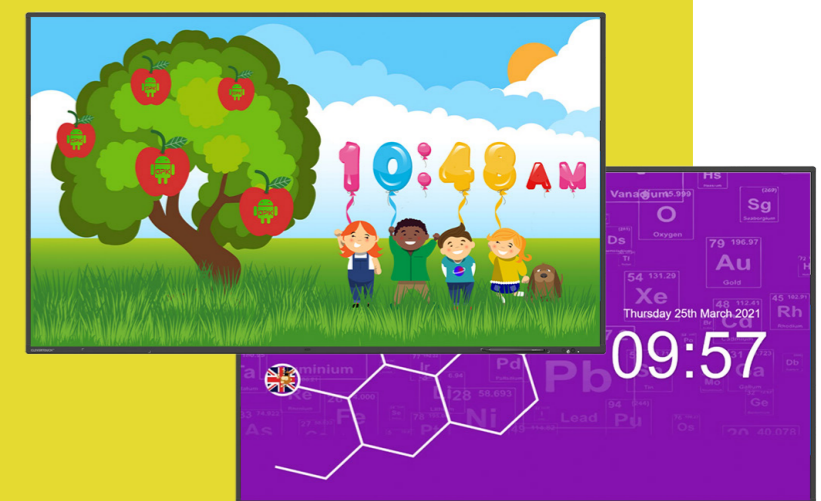



Create teacher or group profiles
Log into any connected screen in your district and get your apps, home screen, settings and more.

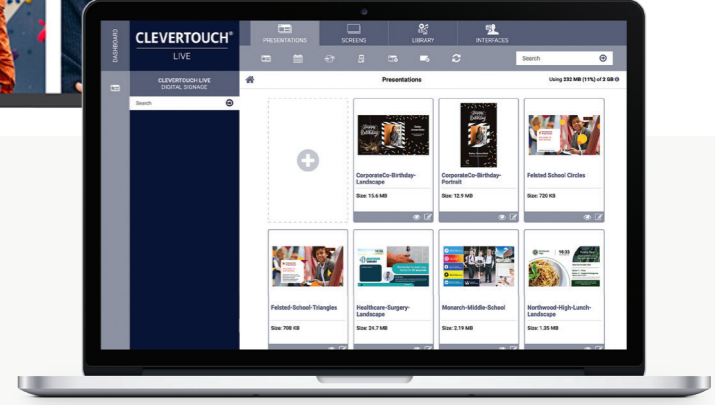

Dynamic and integrated
CleverLive
CleverLive is the Content Management System Platform (CMSP) for all Clevertouch Technologies innovations.

- Personalise your launcher page**
- Display digital signage messaging when it's not in use.
 - Add apps from the Cleverstore or upload your own apk files – send to all your interactive displays without needing to manually install them on individual screens.
 - Send alerts and announcements to your audience.
 - Weather warnings, stranger alerts, fire alarms.
 - Call staff/students to other locations.



Create your free account at CleverLive.com

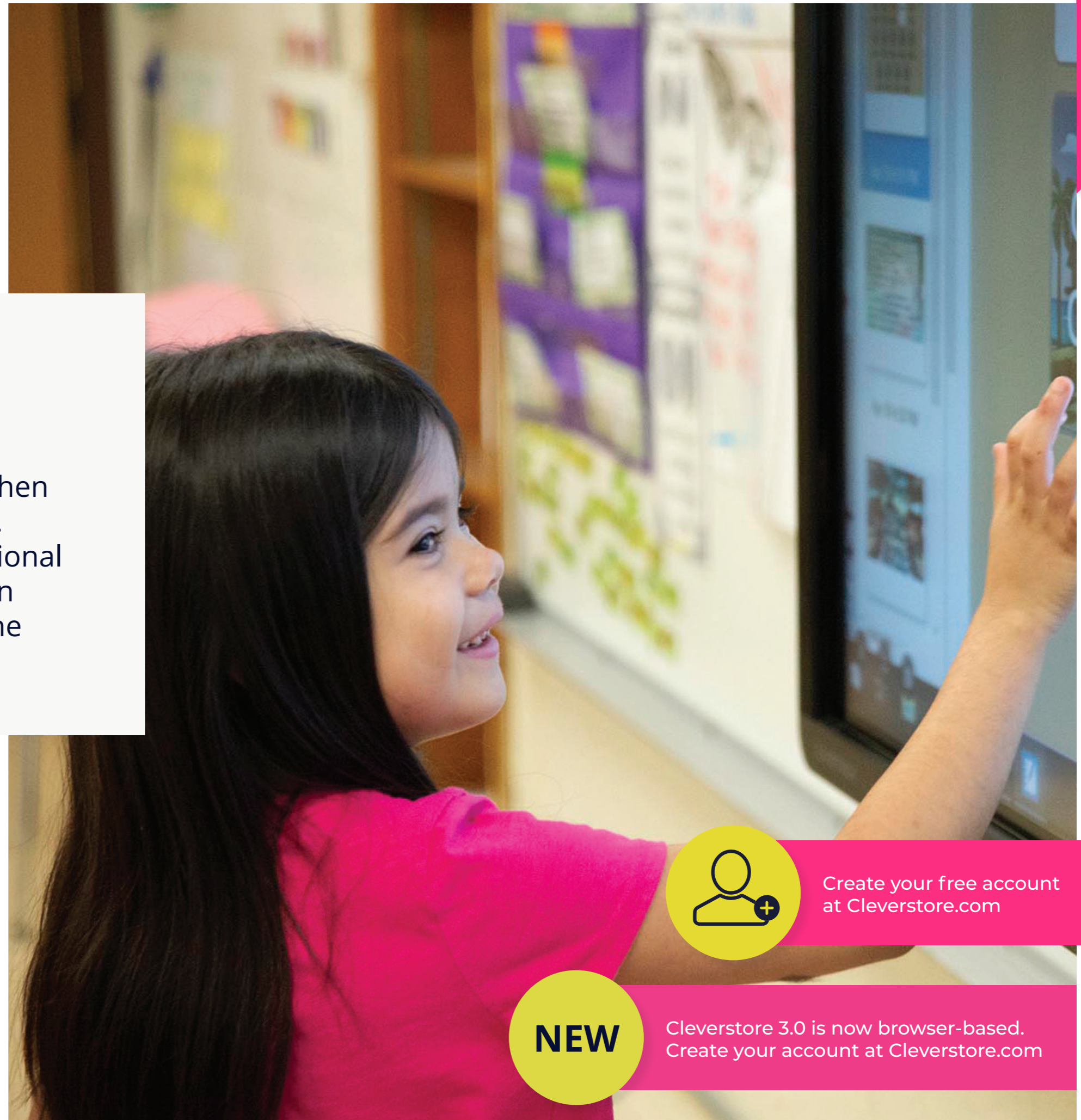

Increase Student Engagement

Cleverstore 3.0 NEW

It's easy to hold students' attention when there's something new on the screen. We've hand-picked apps from educational app developers that support Common Core State Standards in the US and the National Curriculum in the UK.

Apps for everyone

With apps for all ages and in most subjects, there are loads to choose from to help support your lessons. From Coding to Math, Literacy, and Science, as well as games and stories, Cleverstore has everything you could need.

Dual language

Not only are most of our apps available in a variety of languages, but some also support dual language, allowing you to teach languages such as French, Spanish, and German as you go along.

A store you can trust

Our App Team checks every app that's submitted to the store so there is no inappropriate content. We want to enable teachers to download apps as lesson resources – so all apps are suitable for the classroom.



Create your free account at Cleverstore.com



Cleverstore 3.0 is now browser-based. Create your account at Cleverstore.com

Clevershare 5

Collaborate with ease - connect up to 50 devices, including phones, tablets and laptops. Screen mirror with images, video and audio.

With touch-back for two-way control, the presenter has full control over what is shared and can show 9 screens simultaneously, increasing collaboration and participation within every session.

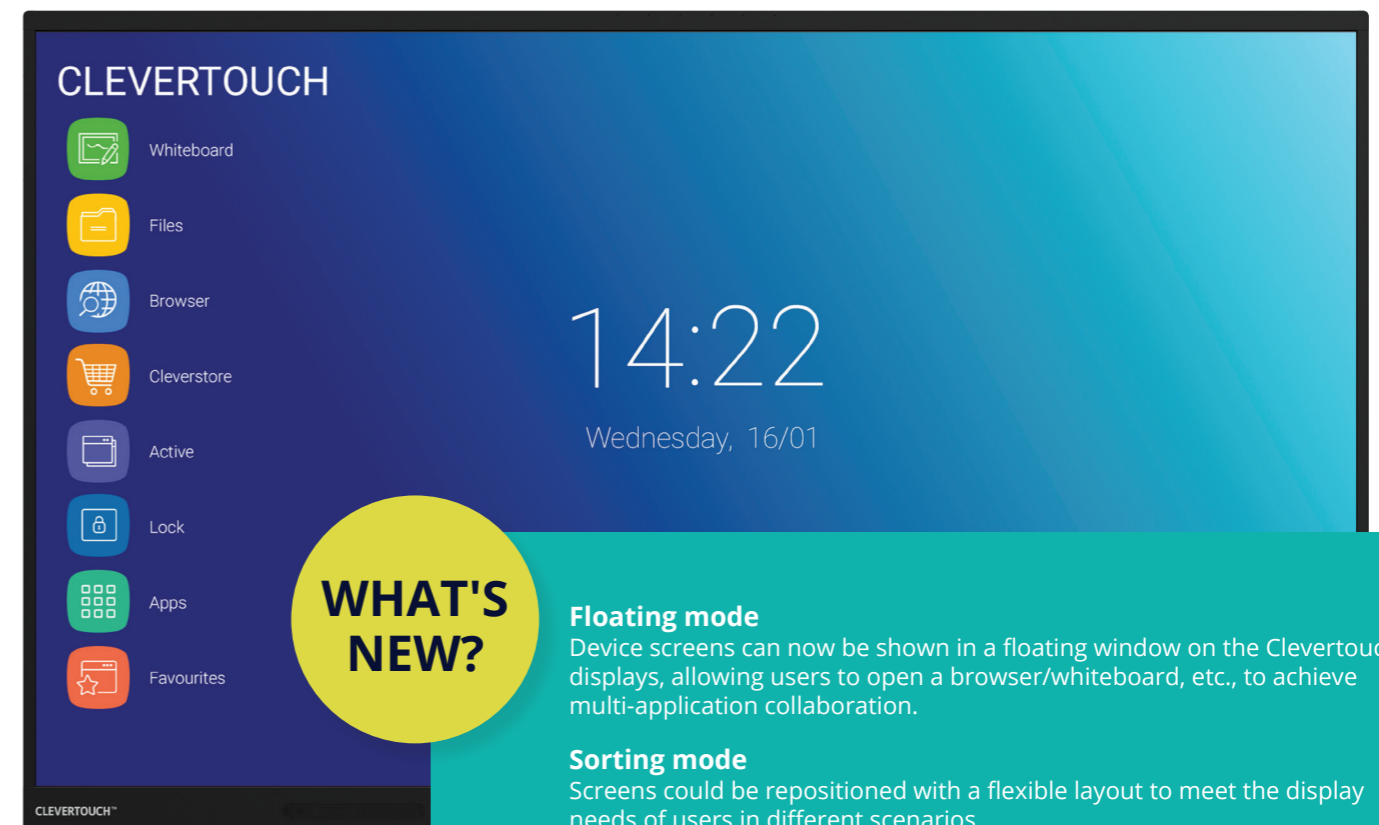

WHAT'S NEW?

Floating mode

Device screens can now be shown in a floating window on the Clevertouch displays, allowing users to open a browser/whiteboard, etc., to achieve multi-application collaboration.

Sorting mode

Screens could be repositioned with a flexible layout to meet the display needs of users in different scenarios.

Image quality

Optimized casting image quality, three kinds of clarity can be selected: ordinary, better, and excellent.

Share content with any device

Up to 50 devices can connect with the Clevertouch screen and share content - images, video, and audio. Now with touch-back for two-way control.

The presenter has full control over what is shared and can show up to 9 device screens simultaneously, increasing collaboration and participation within every session.

Mastering Mode

This optional mode will allow you to manually accept or reject from the Clevertouch screen when someone attempts to connect via Clevershare.

Chromecast and Airplay

There is an optional button you can swipe in the settings that will allow you to natively connect your device this way.

Clevershare App

Any device can download the Clevershare App and connect instantly by typing in the code on the Clevertouch screen. Clevershare App is free to download and compatible with Android, Windows, iOS, and Chrome devices.

Clevershare Dongle (optional extra)

Use the USB-C Clevershare dongle to share content. No need to download any app or driver, so ideal for companies that do not allow downloads to devices.

How to connect

You can connect via the Clevershare App if your device is on the same Network as the Clevertouch. Use Advanced Mode for additional encryption and dual sub-networks. There is a Hotspot option if you are unable to use the network.



Optional Extra



Clevershare Dongle

- USB-C connection
- Compatible with IMPACT Max
- Works in conjunction with the Clevershare app

Clevershare App

- Works on any device
- Free to download
- Compatible with Android, Windows, iOS & Chrome Devices

With AirServer you can mirror content from your personal device to the Clevertouch panel without needing to download an app.

Key Features

AirPlay

Used by macOS, iOS and iPadOS devices.

AirServer has support for AirPlay mirroring, media as well as audio-only streams.

Bluetooth discovery.

Support for PIN, password, and on-screen prompt for incoming connections.



Google Cast

Used by Android and Chrome OS devices and is included in Chrome and Edge browsers.

AirServer has support for both Google Cast mirroring and media (casting from apps).

Casting from apps is also available from iOS and iPadOS. DRM protected content is supported if the host device has DRM support.

Google Cast has no PIN support, but AirServer has a prompt option to accept connections.



Miracast

Used by Windows 10 devices as well as some Android devices (Samsung, LG, Huawei and more).

AirServer has support for UIBC (touchback) and hardware cursor that transmits the mouse cursor separately to reduce perceived latency.

Support for PIN code and on-screen prompt for incoming connections.

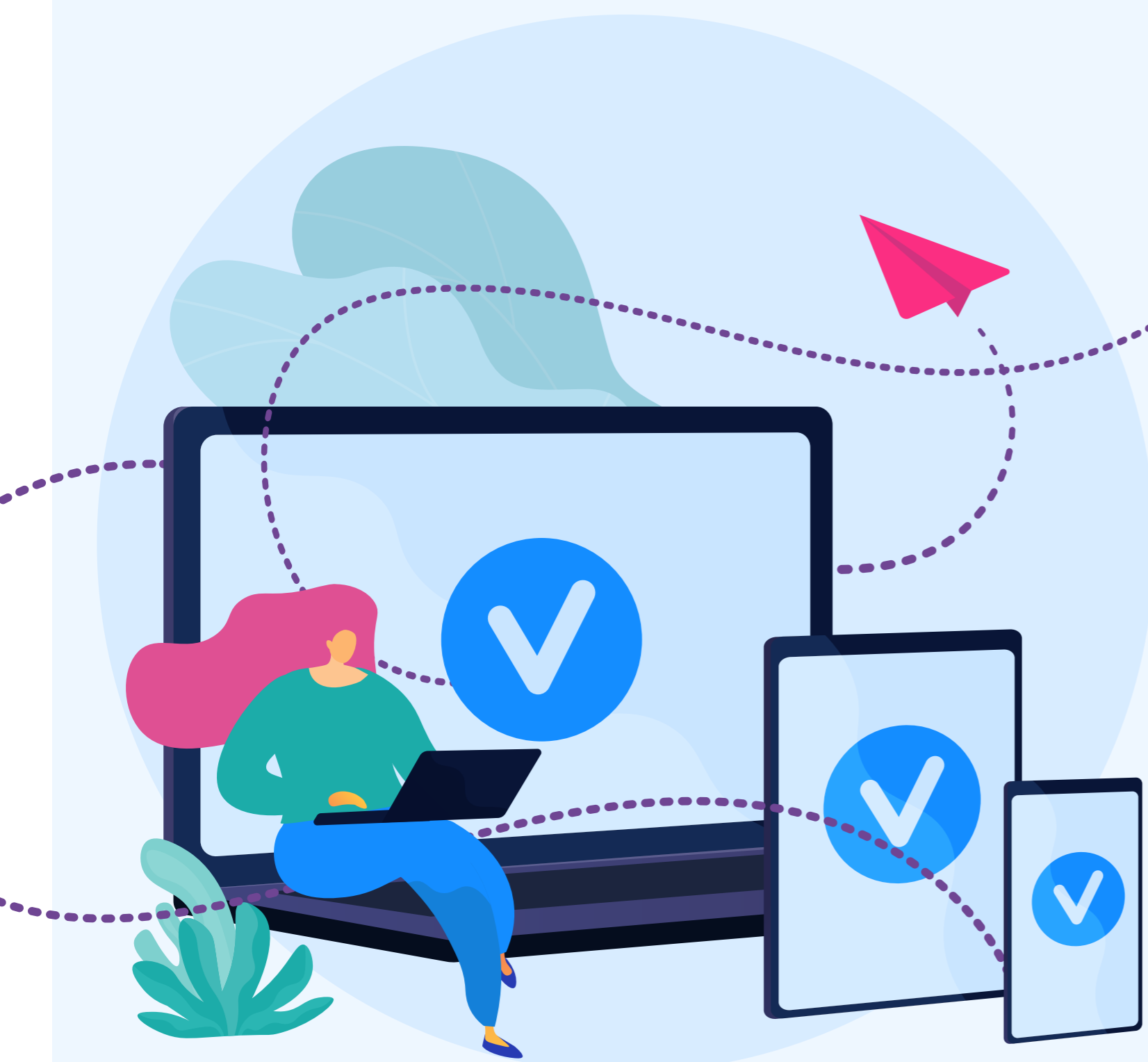

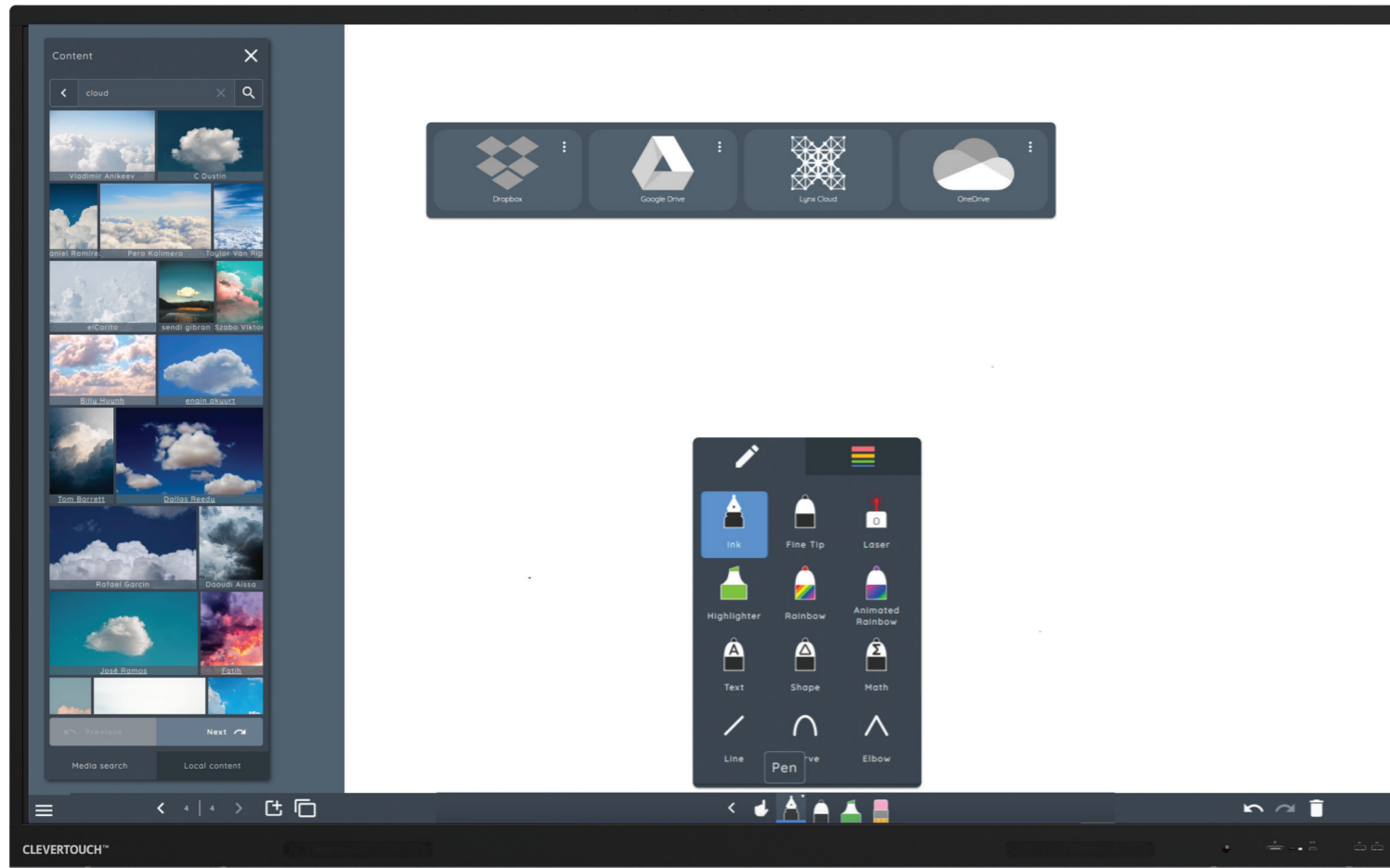

Captivating Lessons

Natural handwriting

Our new pen type allows users to have a more natural feel to their writing. Pressure and velocity will help to decide the thickness of the line as the user writes – like a real pen.

Multi-Purpose

Split the screen so that you can look online while your lesson is open, and drag content across.

Dual Pen

Two users can choose different pens, or different tools, and use them simultaneously, providing a more natural feel.

Increase student Engagement

Search videos from YouTube, images from Unsplash, panoramic images – all without leaving your app. Safe Search enabled, ensuring content is suitable for children.

Get Creative

With dozens of teaching tools at your fingertips.

Fun, Shareable Activities

Create your own activities with customizable content. Activities will automatically be saved to your LYNX Cloud, so that you can share them with colleagues.

Collaborate with ease

Students can scan a QR code with their personal device and either join the activity during the lesson, or save it to do at home.

Quickly switch formats

Convert files from Office formats into LYNX files, ready to be used within LYNX. Word, Excel and PDF files can easily be converted. Drag interactive whiteboard or Smart Notebook files in bulk and they will automatically convert into a LYNX file.

Whiteboarding made easy with a huge selection of pen & art tools to choose from

LYNX Whiteboard

The most dynamic, intuitive user experience of any whiteboard – completely redesigned for a touchscreen, with drag and drop, pinch to zoom, and easy swipe menus.



LYNX Whiteboard has now partnered with PhET to give you over 80 FREE STEM activities to use in your classroom or set as homework.



Cloud access for distant learning with LYNX Whiteboard

Hundreds of tools to increase student engagement in a blended learning environment.

Access the cloud & Log in from anywhere

Create lessons on the go, at home, or in another classroom, on any device.

Your school can set up a LYNX Cloud account, so content and resources can be shared.

Great for distance learning

Set work, deploy and give students their own log-ins.

Download & Upload

Log into any Clevertouch and download your LYNX files, great if you aren't in your usual classroom.

Set Homework

Set homework activities for your students

Sync with other cloud-based drives

Get content from Dropbox, OneDrive, LYNX Cloud or Google Drive and input it directly into your lessons



CleverCam

CleverCam is a 4K ultra-high definition ePTZ camera with a sleek, eye-catching design. CleverCam employs advanced ISP processing algorithms to provide vivid, vibrant images with uniform clarity, brightness, strong colour layering, high resolutions and fantastic colour rendition. With it's great functionality and superior performance, CleverCam is easy and convenient to install and maintain.



Key Features

Ultra HD 4k Resolution | ePTZ | Video output interface

1/2.8 inch high quality CMOS sensor. Resolution is up to 4k with frame rate up to 30fps (MJPG) or 30fps (H.264); compatible with 1080P and 720P; ePTZ and 10x digital Zoom; Video output interface USB 3.0

Multiple Installations | Easy to use

Standard equipped with mold clamp. Easy to install on any device, such as LCD screen, laptop, table and tripod; no need to download driver; USB 3.0 Plug and play.

Wide Field of View

83°/100° wide angle and small distortion lens options; Supports H.264, MJPG, YUY2, NV12 video compression, to made video play smoothly.

Built-in MIC

Built-in two omni-directional MIC pickups; with unique noise suppression algorithm.

Auto Framing

CleverCam uses a face-detection algorithm to automatically centre the camera frame to the person talking, whilst still ensuring that the other people in the room are in-view.

Technical Specification

View Angle	115°(D) / 100°(H) / 56°(V)	SNR	>55dB
Focal Length	f=2.26mm	USB	
Iris	F1.8	Video Compression	YUY2, NV12, MJPG, H.264, H.265
Image Sensor	1/2.8 Inch High Quality 4K CMOS Sensor	Operation Systems	Windows 7 (1080P or lower), Windows 8.1, Windows 10; macOS™, 10.10 or higher, Linux (UVC support); Android
Effective Pixels	8.28MP, 16:9	USB Audio	Support
Video Output	USB3.0(Type B), audio video outputs LAN: 10M/100M/1000M adaptive Ethernet port,audio output supported (The default model without LAN)	USB Protocol	UVC, UAC
Video Compression	USB 3.0:YUV2, NV12, MJPG, H.264, H.265 LAN:H.264, H.265	PTZ Control	EPTZ
Audio Input	2 Micro omnidirectional pickups	Hardware Requests	2.4 GHz Intel® Core 2 Duo Processor or better, 2GB Capacity or more, USB 2.0 Input (USB3.0 for 4K)
Video Resolution	Main Stream: 3840×2160 @30fps, 1920×1080P @30fps / 25fps, 1280×720P @30fps / 25fps Sub Stream:1280×720P @30fps / 25fps, 640×480P @30fps / 25fps 320×172P@30fps / 25fps	Other Parameters	
Digital Zoom	10X	Working Voltage and Current	USB power supply 5V POE power supply 48V USB power supply 1A (max) POE power supply 0.104A (max)
Illumination	0.1Lux (F1.8, AGC ON)	Power Consumption	5W (max)
DNR	2D&3D DNR	Stored Temperature	-10°C ~ +60°C
Super Low Illumination	On/Off	Stored Humidity	20% ~ 95%
Focus	Auto / Manual / One Push	Working Temperature	-10°C ~ +50°C
White Balance	Auto / Manual / One Push//3000K/3500K/4000K/4500K/5000K/5500K/6000K/6500K/7000K	Working Humidity	20% ~ 80%
Exposure	Auto / Manual	Dimension (W*H*D)	180mm × 42.5mm × 46.3mm
Backlight Contrast	On/Off	Weight	Around 0.3kg
		Accessory	User Manual, Warranty card, USB3.0 cable, IR Controller



MIC
Built-in two omni-directional MIC pickups

Sensor
1/2.8 inch high quality CMOS sensor

Audio/Visual
Multiple Audio/Visual Compression Standard



Intelligent Sensor Module

Use either an NFC card or a RFID fob to sign-in within seconds, giving you access to your favourite apps, your cloud accounts and your preferred settings.

The intelligent sensor module device slots onto the bottom of your IMPACT Plus 2.0 or UX Pro 2.0 display. Our sensors keep track of air quality, light, temperature and humidity.

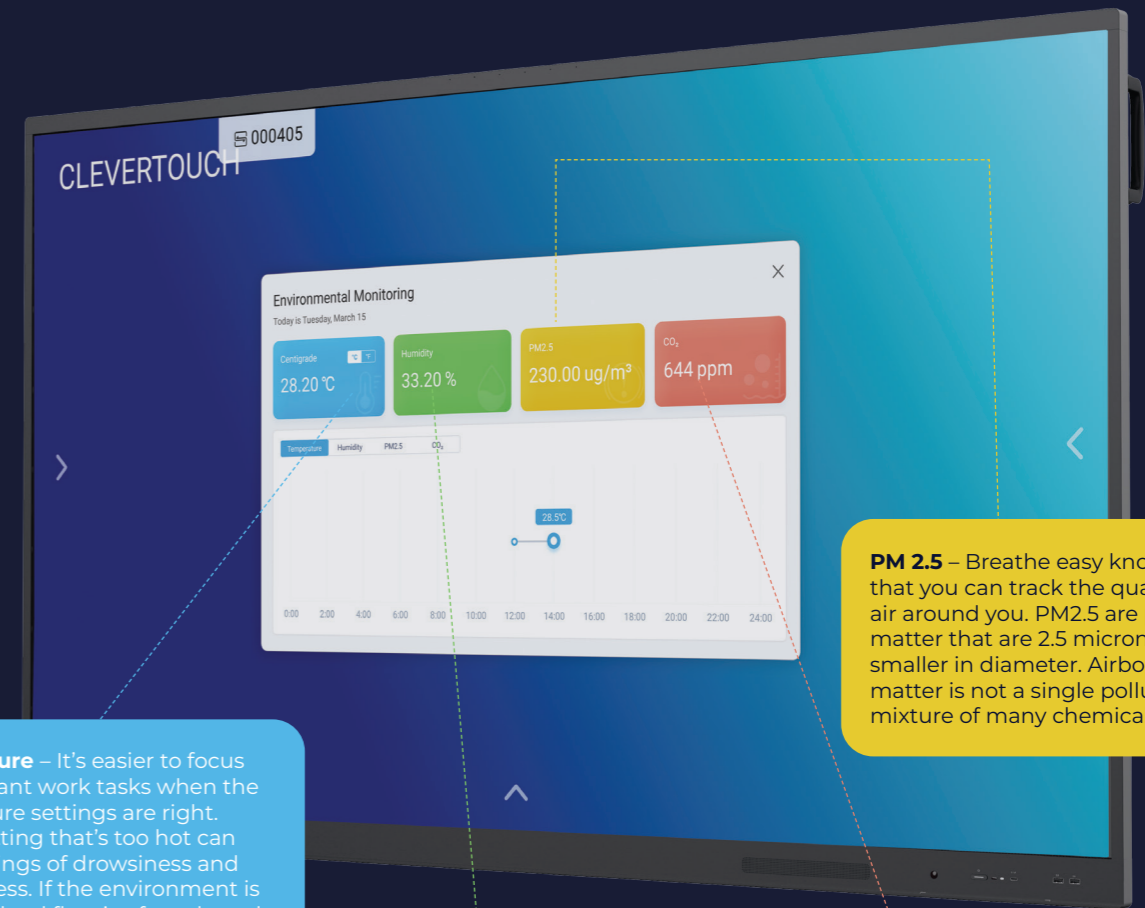
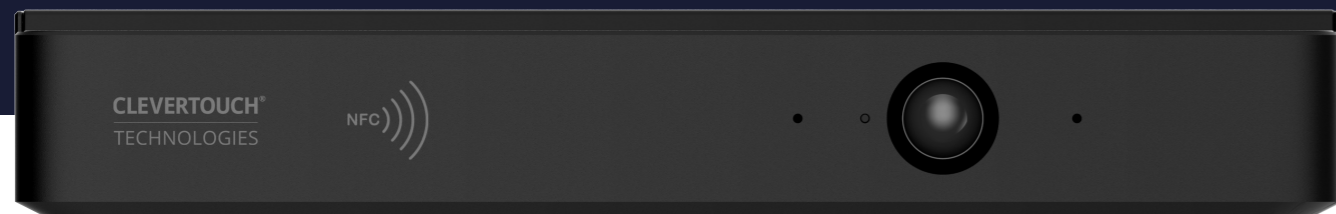

Temperature – It's easier to focus on important work tasks when the temperature settings are right. A work setting that's too hot can cause feelings of drowsiness and sluggishness. If the environment is too cold, blood flow is often slowed and can cause your staff to feel more lethargic.

Humidity – Essential to human health, low humidity allows germs to spread further and irritates the airways, whilst high humidity can cause problems that contribute to allergies. The optimum range of humidity for human health is 30-50%.

PM 2.5 – Breathe easy knowing that you can track the quality of the air around you. PM2.5 are particle matter that are 2.5 microns or smaller in diameter. Airborne particle matter is not a single pollutant, but a mixture of many chemicals.

VOCS - VOCs include a variety of chemicals that can cause eye, nose and throat irritation, shortness of breath, headaches, fatigue, nausea, dizziness and skin problems. Higher concentrations may cause irritation of the lungs, as well as damage to the liver, kidney, or central nervous system.



Standard Specifications

PIR Sensor	Detection Distance	3-5M
	Detection Angle:	H:±40°(80°) V:±27.5°(55°)
Humidity	Accuracy	±5%
	Range	5%RH to 95%RH
Temperature	Accuracy	±1-2°C
	Range	-20°C-85°C
NFC	Operation Mode	Reader/Writer
PM 2.5	Detecting Distance	3-5cm
	Supporting ISOs	15693 @ 13.56MHz and 14443 @ 13.56MHz
	Detecting Range	0-10000µg/m3
	Response time	<2s
VOCS	Detecting Range:	400-29000ppm

Power

Internal Power	5A/1A
-----------------------	-------

Physical Specifications

Dimension (package) L×W×H	206*69*31.7mm
Dimension (package) L×W×H	275*228*63mm
Net Weight	180g
Gross Weight	TBD

Environmental Conditions

Operation Temperature	0°C - 4°C
Operation Humidity	10% - 90%RH
Storage Temperature	-20°C - 60°C
Storage Humidity	10% - 90%RH
Altitude	Below 5000 meters

What's Included

NFC Card	x1
User Manual	x1

Product Technical Drawings

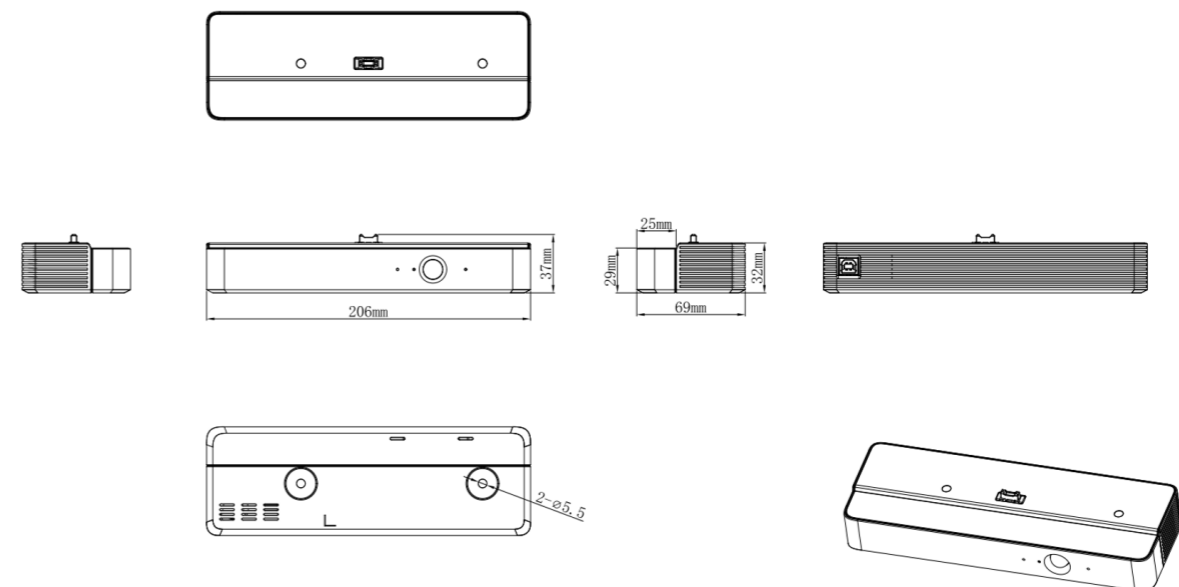



Take Control

Remote Management

IT departments & administrators can take control, without needing to leave their office. Control multiple Clevertouch devices by linking your entire fleet of Clevertouch screens to your Remote Management MDM account, so that you can control them from anywhere.

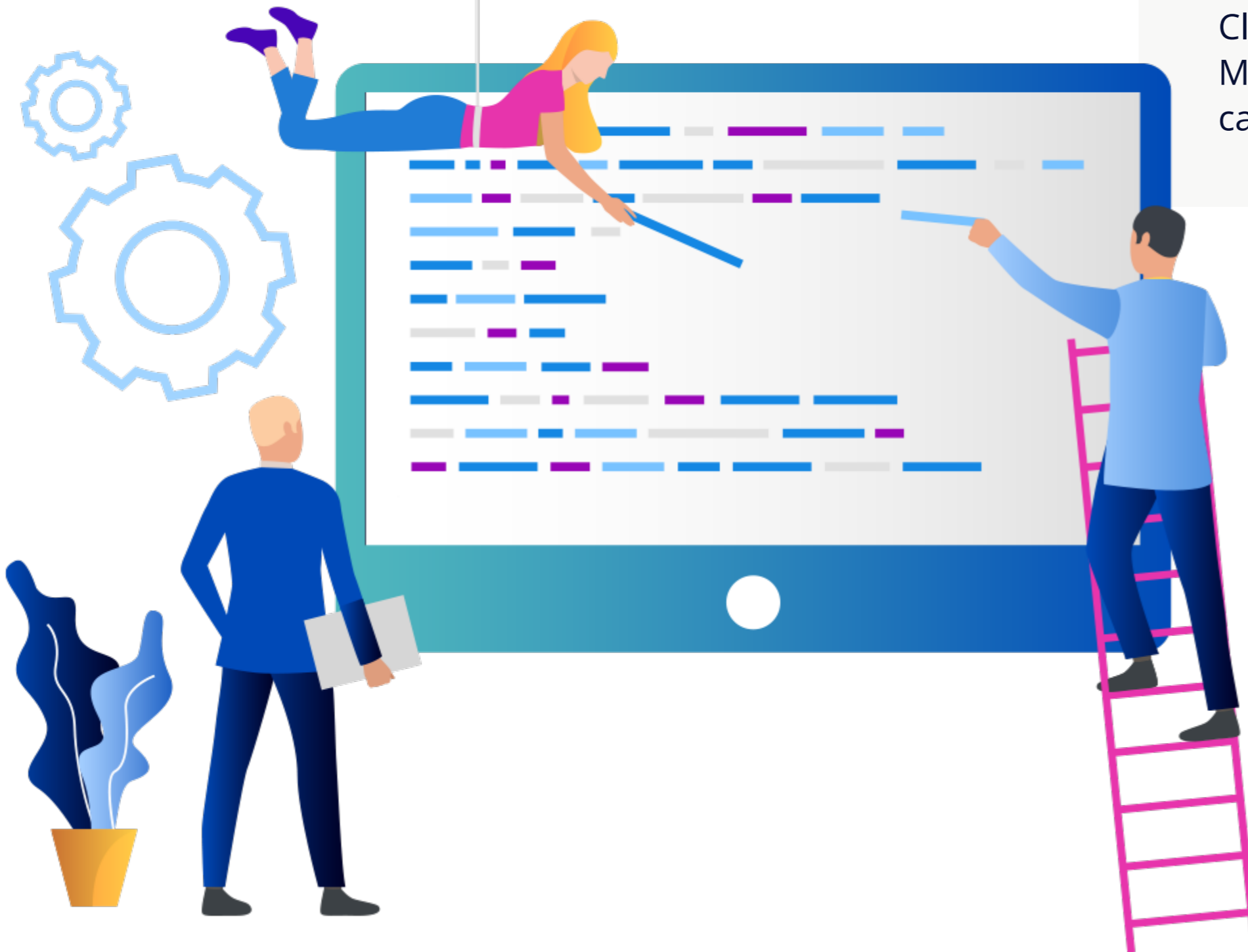

Update or remove apps

With the functionality to add .apk files to some or all of your Clevertouch displays, your organisation can always have the latest apps available to use.

Over-The-Air updates

Our OTA updates are just one click away to get the latest firmware on your screen. We will never charge you for firmware updates.

View status information

IT managers can troubleshoot without needing to leave their office. Look up individual Clevertouch screens, view the display in realtime, edit settings, or restart devices remotely.

Group and tag

If you have a group of screens being used by a certain department, you can deploy the same apps and settings, so that there is a standardized experience for everyone in that department.



Display

Diagonal Size	55" 4K, 65" 4K, 75" 4K, 86" 4K
Screen Type	TFT LCD - Direct LED Backlight
Aspect Ratio	16:9
Display Colours	1.07 Billion (10bit)
Resolution	4K UHD (3840 x 2160)
Response Time	5ms
Refresh Rate	60Hz
LCD Viewing Angle	178°
Brightness	450 cd/m2
Contrast Ratio	55" 4500:1
	65" 4500:1
	75" 4500:1
	86" 4500:1
Dynamic Contrast Ratio	55" 5000:1
	65" 5000:1
	75" 5000:1
	86" 5000:1
Glass Hardness	AG Tempered Glass - Mohs Level 7
NEW Glass Type	Low Parallax Zero Bonding - Heat tempered - Anti Glare - Super Glide Surface - 4mm
NEW Main Board	9950 MTK (MStar)
Life of Screen	50,000 hours

Interactivity

Writing Technology	High Precision IR Technolgy
Continuous Touch Points	20
Touch Resolution	32768x32768
Response Time	≤5ms
NEW Touch Accuracy	1mm
Minimum Object Size	3mm
Touch Tool	Finger, Gesture, Passive Infrared pen
Simultaneous Writing	Yes
Ink in Tools	Yes - LYNX
Pens Included	2
Pen Type	Dual Recognition Stylus
Pen Holder	Integrated Full-length Pen Tray
Pen Tip Diameter	3mm/7mm
Pen & Touch Differentiation	Yes
Pen Identities	2
Palm Rejection	Yes
Annotation Over Any Source	Yes
Classroom Essential Apps	Includes Whiteboard, Annotate, Timer, Media Players, Browser, PDF Reader, Screen Record, Spinner, Voting, Maths Tools
Compatibility	Windows 10, Linux, Mac, Android, Chrome
Tracking Rate	6m/s
Scan Rate	200Hz
Gestures & Edge Swipes	Windows Supported, OSX with additional Driver

Connectivity

OPS Slot	1 - Intel® spec 80Pin
HDMI In	3
HDMI Out	Using a USB adapter included in the accessory box
USB-A 2.0	1 (1 USB for system upgrade)
USB Touch (type B)	2
NEW USB A 3.0 (Faster Data Transfer)	4
NEW USB C	1x USB-C with video, audio, touch, power and hardware optimisation and ethernet – front-mounted (Supports 65W Charging) 1x USB-C with video, audio, touch and hardware optimisation – side-mounted
LAN In (RJ45)	1
NEW LAN Out (RJ45)	1
RS-232	Yes
Wake-on-Lan	Yes
NEW Wireless Adapter 2.0 + WAP	Upgraded
NEW Bluetooth	Yes – 5.0
VGA In	1
Audio In	1 (3.5mm)
Optical Out	1 (Coax)
Headphone	1 (3.5mm)
Total touch out ports	2
NFC Reader / Writer	Optional Extra
Camera	Optional Extra
Proximity Sensor	Yes
WiFi	IEEE 802.11a/b/g/n/ac with 2 × 2 MIMO (hotspot only) (both 2.4 and 5 GHz bands)
WiFi Speed	Capable of speeds up to 433Mbps

Computing

NEW Operating System	Android 11
NEW System Version	LUX 11
NEW RAM	6GB
NEW Internal Storage	64GB
NEW CPU	Quad Core A73
NEW GPU	Mali G52MC2
Android Resolution	4K
Integrated LUX UI	Yes
System Architecture	64-bit

Audio

Dual Front Facing, Bass Enhanced Speakers	2 x 15 Watt Speakers + 15 Watt Subwoofer
Audio Out	Yes
SPDIF / Fibre	Yes
Sound Channel	2.1
NEW Line Array Microphone 6 (noise cancelling)	Yes – Omni-directional up to 8 meters
Super Wide Sound	Yes

Power

Power Requirements	100 - 240 ~ 50/60Hz 3.5A
Power Consumption (Normal)	55" 102W
	65" 117W
	75" 145W
	86" 168W
Power Consumption (Standby)	< 0.5 Watts
Ultra Quiet Fanless Design	Yes

Operating & Storage Environment

Operating Temperature	0° to 40°
Storage Temperature	-20° to 60°
Operating Humidity	10% to 90% RH
Storage Humidity	10% to 90% RH
Altitude	Below 5000 metres

Physical Specifications

Panel Dimensions	55" 1262x794x89mm
	65" 1488x920x90mm
	75" 1709x1043x89mm
	86" 1957x1182x86mm
Packed Dimensions	55" 1428x220x902mm
	65" 1628x208x1024mm
	75" 1860x280x1163mm
	86" 2112x280x1304mm
Net Weight	55" 27.7Kg
	65" 37.3Kg
	75" 51.1Kg
	86" 63.8Kg
Packed Weight	55" 33.9Kg
	65" 45.7Kg
	75" 63.9Kg
	86" 78.9Kg
VESA Mount Point	55" 400x200mm
	65" 400x200mm
	75" 800x400mm
	86" 800x600mm

Warranty

Warranty term and upgrade options vary by region. Contact your local reseller or distributor for information and visit clevertouch.com/about/warranty

Compliance & Certification

Regulatory Certification CE, FCC, UL, Energy Star & EEC



IMPACT™ Built-in Features

LYNX™ App With Online Lesson Planning	Yes - LYNX Whiteboard is the default whiteboarding app
Cleverstore™ App Store For Education	Yes
Embedded Digital Signage	Yes
Clevershare™ Mirroring Any Device To The Board	Free for the life of the screen (touch back)
Integrated Personalised Accounts Profiles	Yes
Cloud Account Access	OneDrive Google Drive
Embedded Room Booking	Yes
Whiteboard Annotation	Yes
Email Out Direct From Touchscreen	Yes
Scan QR Code For Saving Work	Yes
CleverMessage™ - Instant Alert Messaging	Yes
Over-the-Air Updates	Yes
Remote Management Of Touchscreens (MDM)	Yes - Five year license

Packed Contents - Inside your Clevertouch Box

What's In The Box	(1) Clevertouch IMPACT Plus 2™ (1) 1.5M Length HDMI Cable (1) 3M Length USB cable (A-B) (2) 1.5M USB-C Cable (1) 3M Regional Power Cable (1) 5M 3.5mm Audio Cable (1) Remote Control (2) Batteries for Remote Control (2) Dual Recognition Stylus (1) User Guide (1) Quick Install Guide (1) Wireless Adapter 2.0 + WAP
-------------------	--

Installation

The installation of this product should be completed by a qualified installer. Use of components not supplied by Clevertouch or not meeting minimum specifications may impact performance, safety and warranty. For more information, visit clevertouch.com

Support

For all Clevertouch products, visit: support.clevertouch.com

IMPACT Plus Gen 2 Specifications Diagram

55"

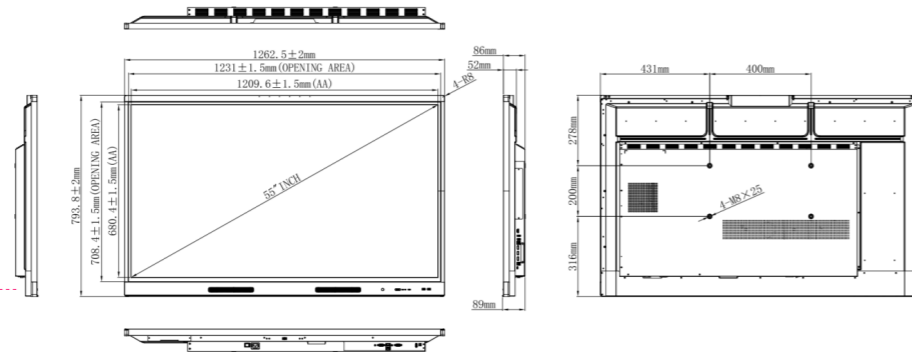

65"

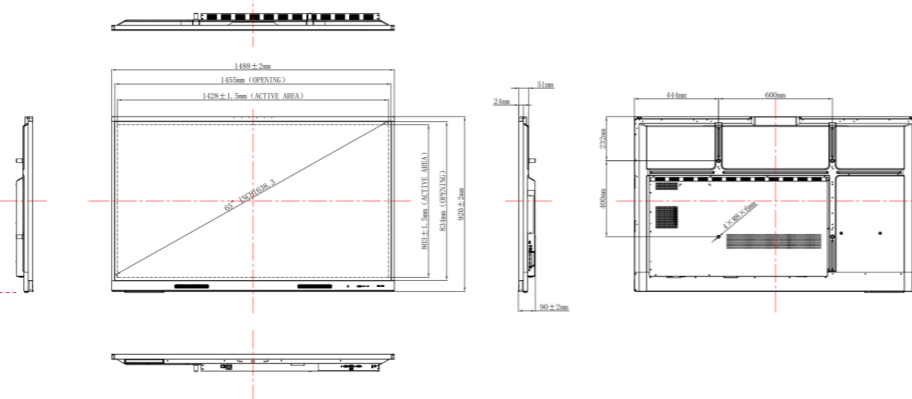

75"

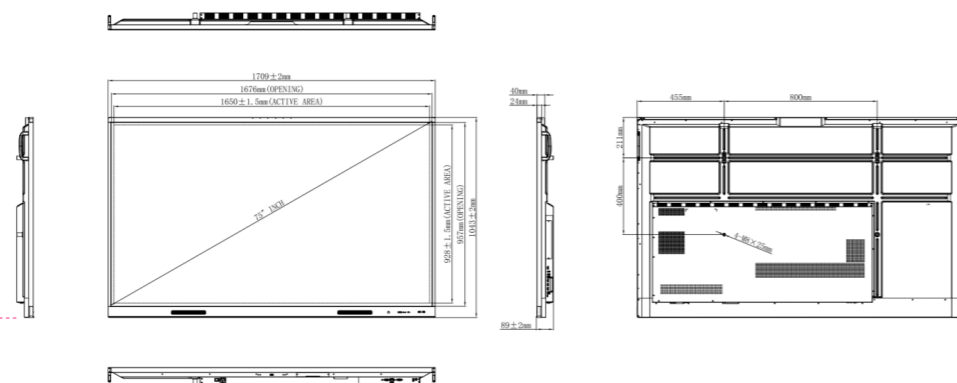

86"

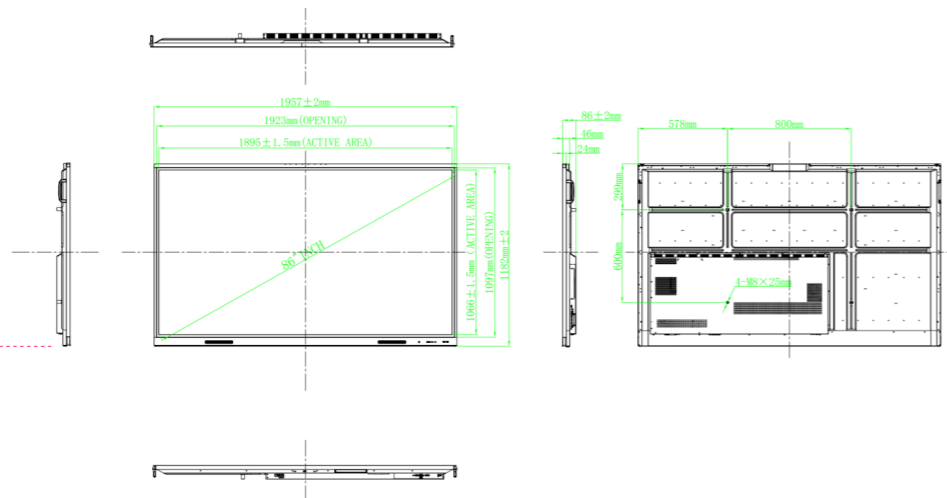

Why Choose Clevertouch Technologies?

- ✓ Trusted Brand
- ✓ No ongoing cost
- ✓ Free training
- ✓ Part of a Digital Ecosystem of products – control them all from one online platform
- ✓ Supports Remote Learning
- ✓ Dedicated Support Team
- ✓ Free updates and new features

Digital Ecosystem

A unique digital solution for every space which redefines the way to distribute information and collaborate using technology.



Our products work together to help your school function smarter!

CLEVERTOUCH[®]

TECHNOLOGIES
by Boxlight[®]

Contact us for
more details

info@clevertouch.com
clevertouch.com